

- 45

1.

- 1,5 (2 .)
- 2,5 (3 .)
- 2 .
- 3,0-4,5 (1 .)
- 0,5 mA (1 .)
- 4

2

- 16

10









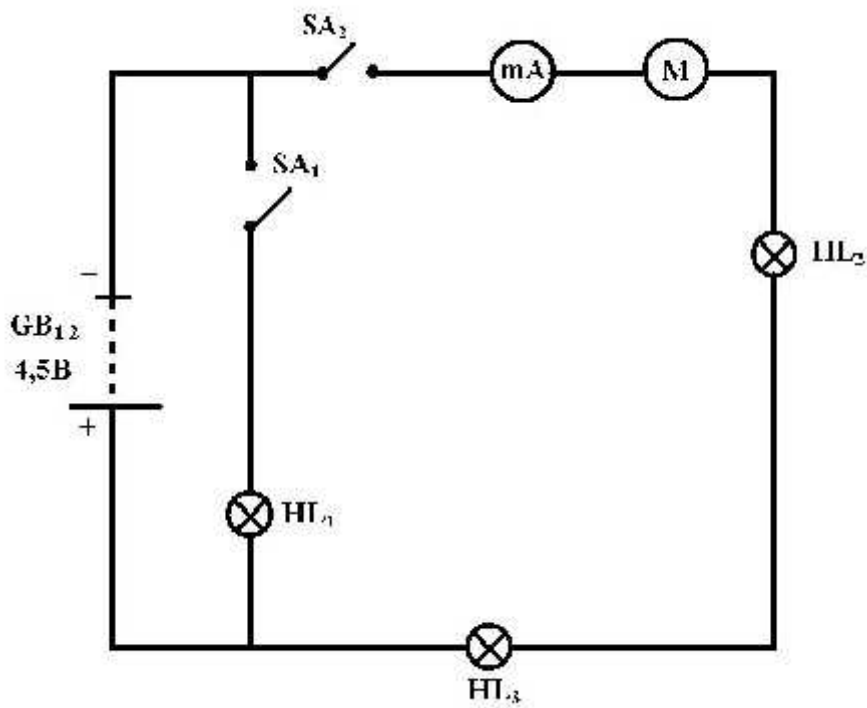

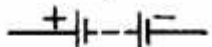
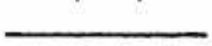







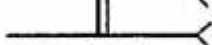

2.

10

- 20

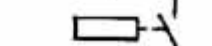
( 1)



Условное обозначение	Буквенное обозначение
	G
	GB
	
	
	
	
	X
	HL
	SA
	XP
	XS
	FV
	
	
	
	
	E
	KA
	HA
	SB
	
	
	
	M